

**Nuewa I9**  
Diagnostic Ultrasound System

Innovation, in every facet



# Innovation

The **Nuewa 19** provides an entirely new experience, thanks to the innovations it features both inside and out. It is characterized by those features that have always been decisive for advanced Mindray ultrasound systems: the revolutionary ZST+ platform elevates ultrasound image quality to a higher level and provides excellent balance for spatial and temporal resolution, and tissue uniformity.

The full-stack smart solution with Smart Scene 3D innovatively provides smartness throughout the whole examination procedure for an extraordinarily easy, accurate, and fast diagnosis. It starts the process using auto clinical scenario identification, and uses automation at every point, from imaging optimization to planes acquisition, quantification, and creating an automated workflow.

You are instantly greeted by an ultrasound system design like nothing you've seen before - coupled with all the latest technologies. **Nuewa 19** boasts an intelligent iConsole control panel with customizable E-ink keys, 15.6" touch screen with intuitive user interaction, auto wake-up of residual power, super-silent design, along with many other high-quality features. These innovative design elements will help to reduce fatigue to a minimum during scans.



# Unlimited scanning flexibility beyond imagination

## iConsole--intelligent control panel

The intelligent and clinical exam-specific control panel layout is a breakthrough innovation designed to optimally adapt to different clinical scenarios, such as OB, GYN, pediatrics and so on. Based on six special E-ink keys with digital screens, iConsole can adaptively adjust the layout and key functions during exam changing. User-define is available for personalized settings and the digital display on E-ink keys will not disappear even during power off.

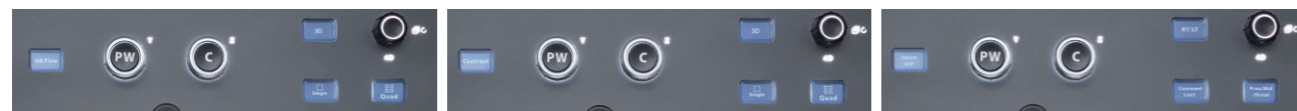

Obstetrics

Gynecology

Pediatrics

## Full-space floating control panel

Instead of 4 or 6 directions adjustment, it can be optimally adjusted in full-space with an extremely broad range and easily locked at any position. So it easily fulfills various scanning requirements in different clinical scenarios for more comfort and care.

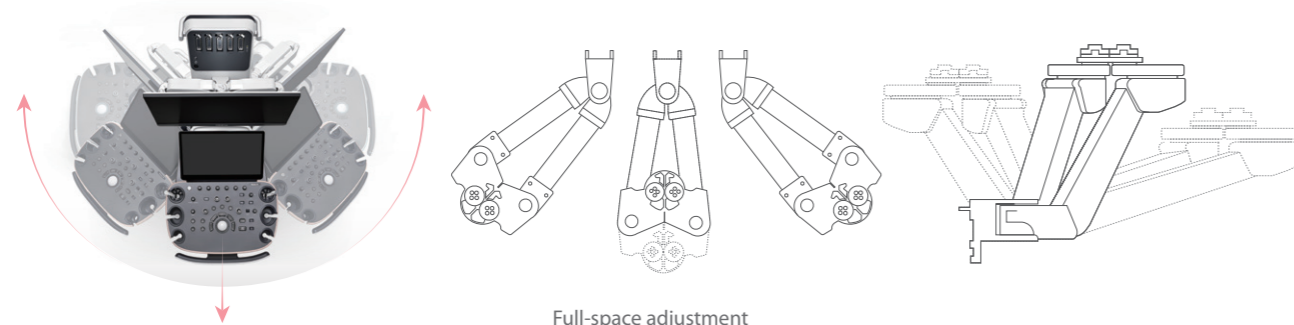

# The ease that you have never experienced before

## Clinical scenario-based ease of use

3D/4D interaction is totally different and becomes extremely intuitive and easy. No more complicated knob adjustments. Just simply click and choose the effect in different scenarios as you want, such as Routine, iLive, Bone, Tissue, Follicle scenarios and so on. All related imaging settings have already been integrated in the system for optimal volume imaging effects.

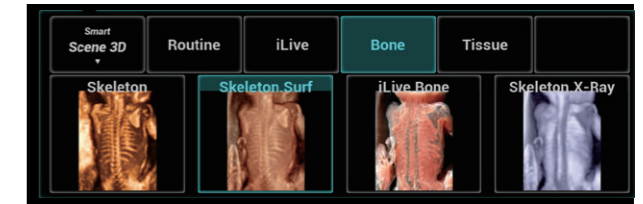

Bone scenario for special bone visualization



Routine scenario for regular practice

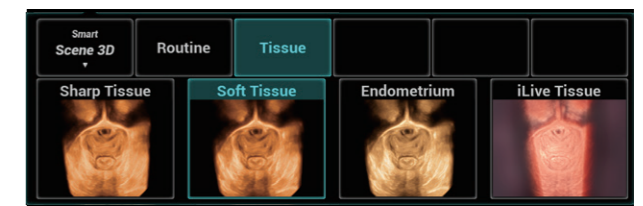

Tissue scenario specially designed for soft tissues



iLive scenario for more realism

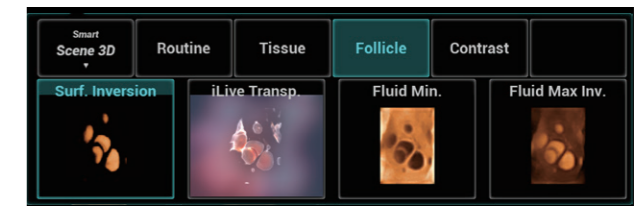

Follicle scenario with multiple follicle effects

## Immersive experience and intuitive interaction

- 23.8" bezel-less full-screen with large images
- 15.6" full-HD touch screen with powerful gesture operation
- Dual screen simultaneous display for both doctors and moms



# Thoughtful design for extreme convenience



## Just fold it up and go

- Minimum 1 meter height, easy transportation of mobile service
- 55cm body width, easy door pass, quick access across clinical departments



## Bedside exams without power cables

- Up to 4 hours continuous ultrasound scanning
- Auto wake-up of residual power when you hold the right handle



## Changing probes without bending

- Elevated sockets for changing probes without bending
- Light indicators for probe activation



## Super-silent design

- 26dB super-silent design as quiet as a bedroom
- More comfort without disturbance

# Full-stack solution powered by ZST+

The ZST+ platform is an extraordinary innovation, representing an ultrasound evolution. Transforming ultrasound metrics from conventional beam-forming to channel data based processing. It overcomes the traditional trade-off limitation among spatial resolution, temporal resolution and tissue uniformity, delivering exceptional image quality for infinite imaging solutions with non-stop improvements.

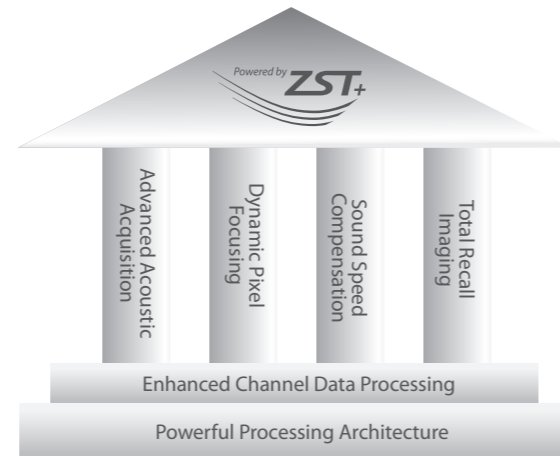

**Nuewa 19** provides a full-stack smart solution for extraordinarily efficient women's and neonatal healthcare. It covers complete applications from pre-pregnancy to obstetric, post-partum and neonatal. What's even more amazing is the full-stack smartness throughout the whole exam procedure: It starts the process using auto clinical scenario identification, and uses automation at every point, from imaging optimization to planes acquisition, quantification, and creating an automated workflow.

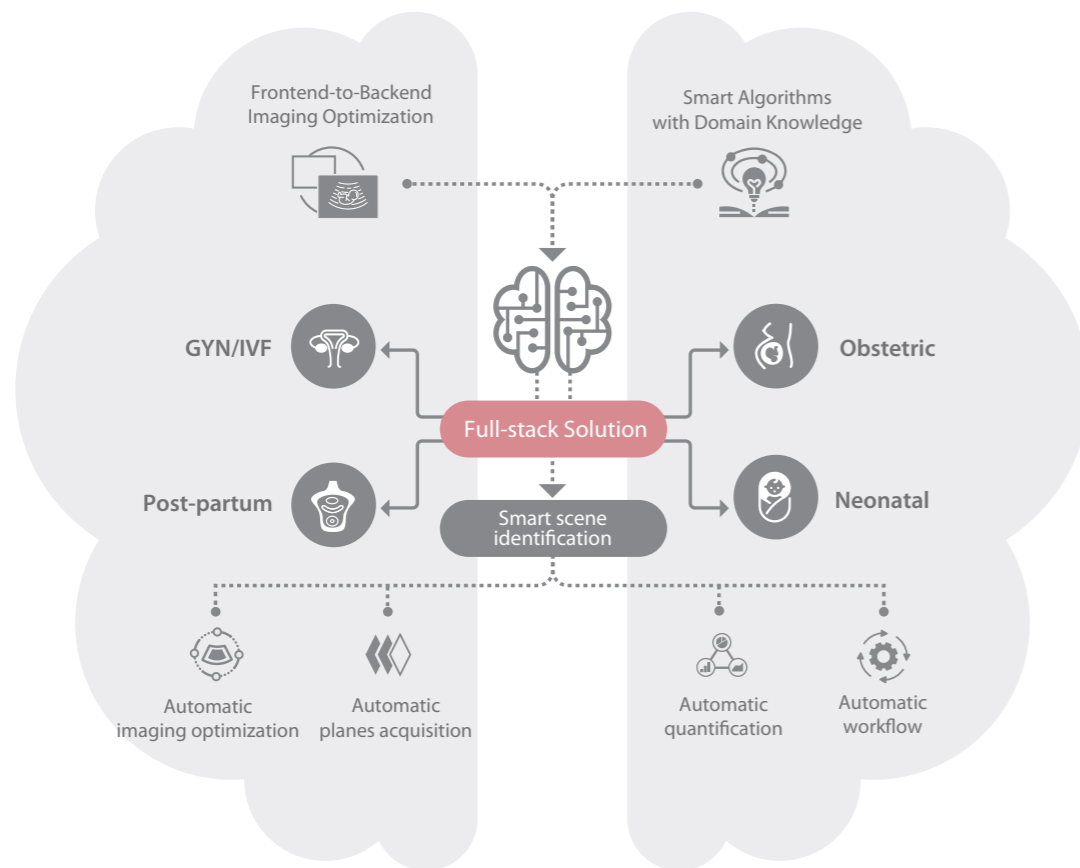

# Clinical scenario-based smartness

## Smart Scene 3D

The innovative Smart Scene 3D is a smart scenario-oriented volume scan technique. By combining advanced algorithms with domain knowledge, it automatically enables the identification of tissue characteristics and provides an organ-specific diagnosis with full-stack smartness from imaging optimization, to planes acquisition, quantification and with automated workflow throughout whole procedure.

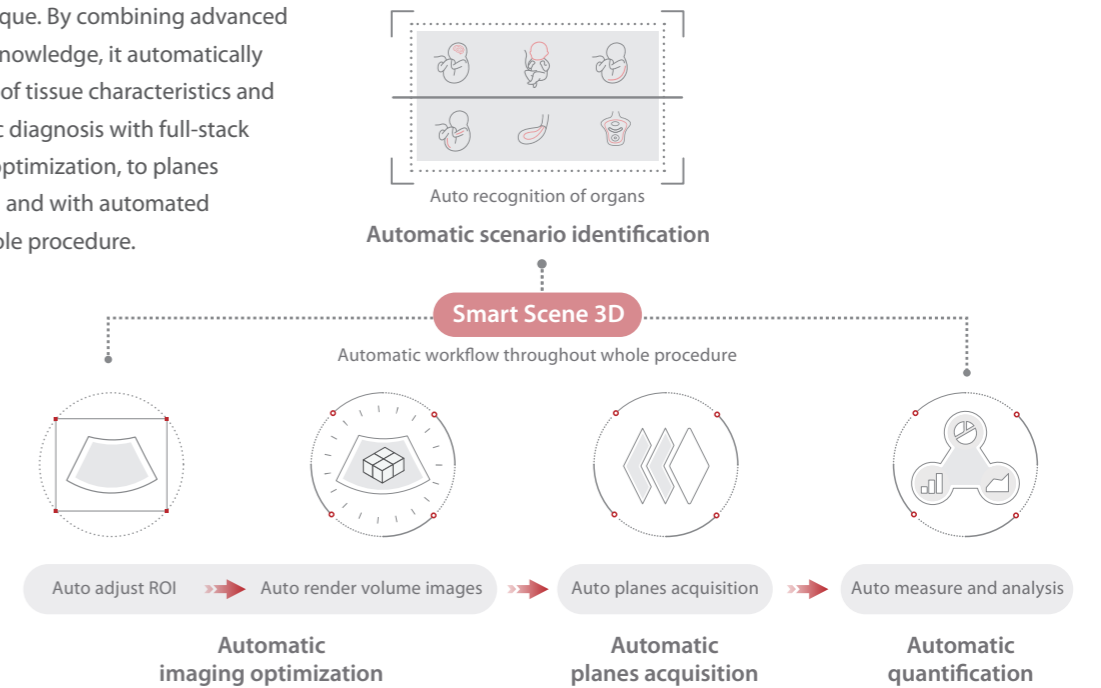

Smart Scene 3D is widely used in women's healthcare in pre-pregnancy, obstetric and post-partum exams. As an evolving technology, it will be continuously extended and further developed in the future.

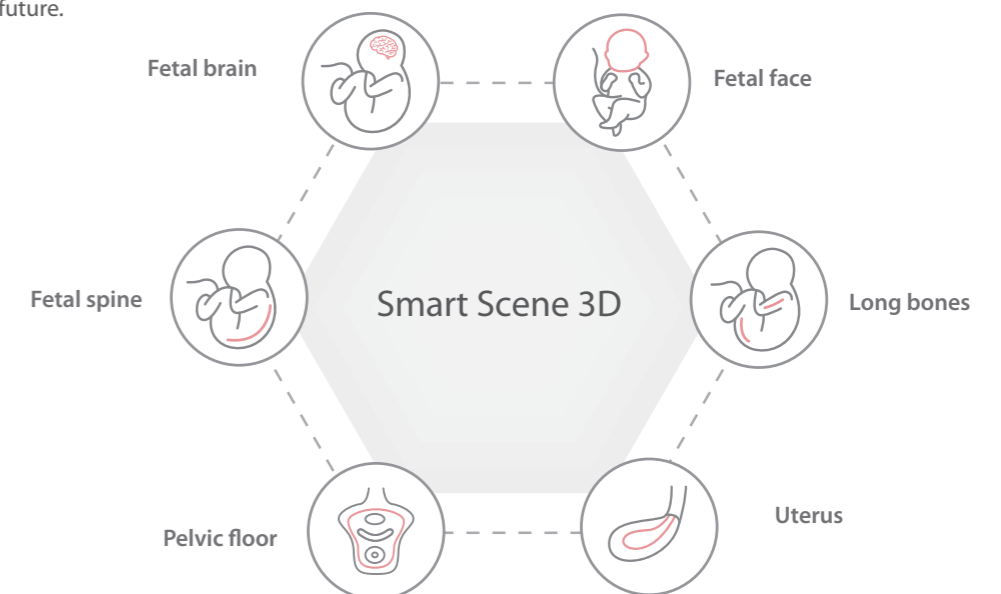

# Reproductive health solution

## Smart endometrial receptivity analysis -- Smart-V Trace

It effectively detects anatomical structures with even weak boundaries, such as endometrium. In addition, comprehensive assessment of vascular footprint and blood flow intensity in target area is provided to ensure more diagnostic information for endometrial receptivity and tumor blood flow distribution.

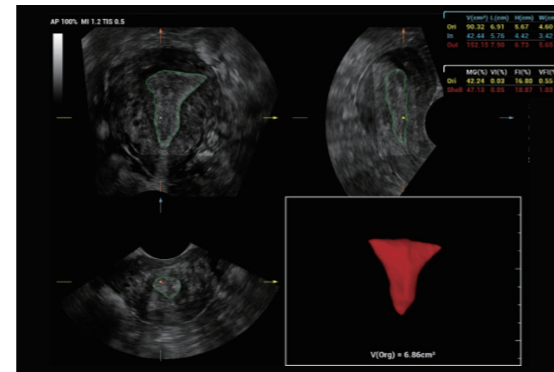

Smart-V Trace

## Fallopian tube patency assessment -- 4D HyCoSy

The very helpful infertility diagnosis tool 4D HyCoSy is a simple and well-tolerated ultrasound procedure used to assess the patency of fallopian tubes, as well as detect abnormalities of the uterus and endometrium.



4D Hycosy

## Smart follicle study for IVF -- Smart FLC

Smart FLC automatically detects the number of follicles and calculates each volume from a 3D ovarian volume image, ensuring accurate assessment of follicles, essential for IVF exams.

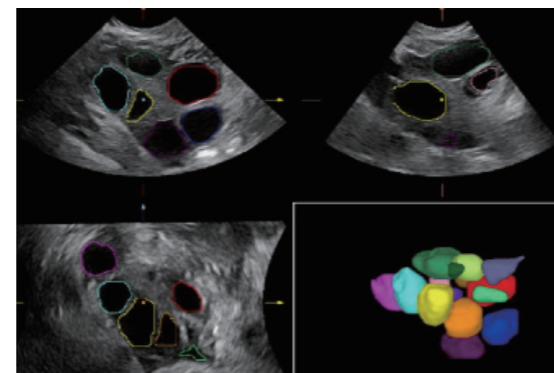

Smart FLC

# Obstetric solution

## Unprecedented realism and clarity -- iLive with Hyaline

By mimicking multiple light sources of variable intensity, iLive helps to significantly improve the detailed resolution as well as anatomical realism for both surface and internal structures. High-speed volume rendering is powered by ZST+ platform.

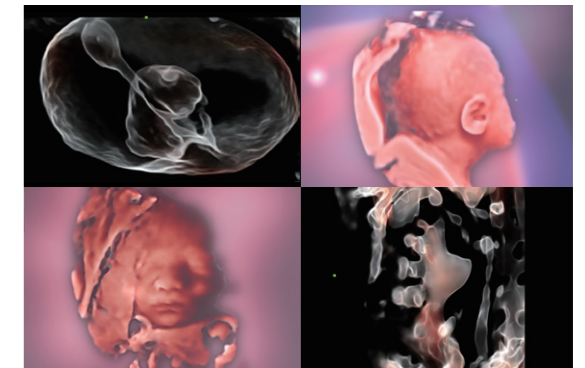

iLive with Hyaline

## Smart and accurate fetal CNS study -- Smart Planes CNS

Mindray's pioneering technology to allow fully automatic and accurate detection of the most significant planes (MSP, TCP, TTP and TVP) and frequently-used measurements (BPD, HC, OFD, TCD, CM and LVW) of fetal CNS, leading to a smart diagnosis, improved throughput, and reduced user dependency.

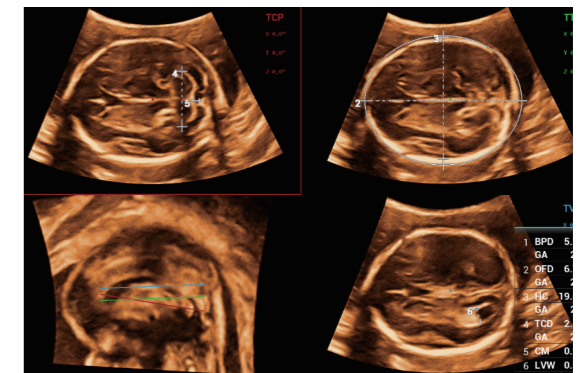

Smart Planes CNS

## Efficient and precise intra-cranial volume evaluation --- Smart ICV

Smart ICV enables auto fetal brain segmentation and realizes fully automatic measurement for fetal intra-cranial volume study. With minimum user manipulation, Smart ICV offers the extremely smart and efficient ICV measurement with guaranteed accuracy.

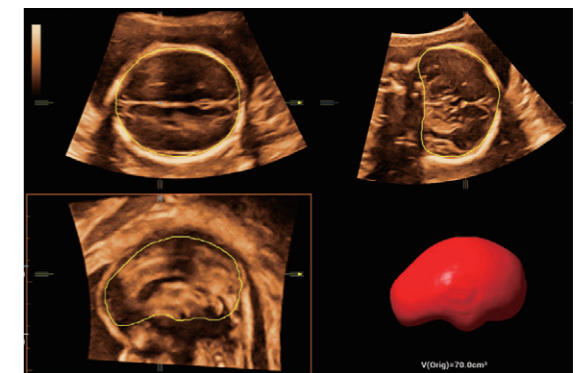

Smart ICV



## Neonatal Solution

### Reliable and smart DDH screening --- Smart Hip

Smart Hip is a simple and efficient tool for accurate and reliable DDH (Developmental Dysplasia of the Hip) screening and diagnosis. It innovatively provides auto detection of hip structures and auto measurement of  $\alpha$  and  $\beta$  for easy Graf classification. Just a simple click for quick exam, so less impact due to poor cooperation of the newborn.

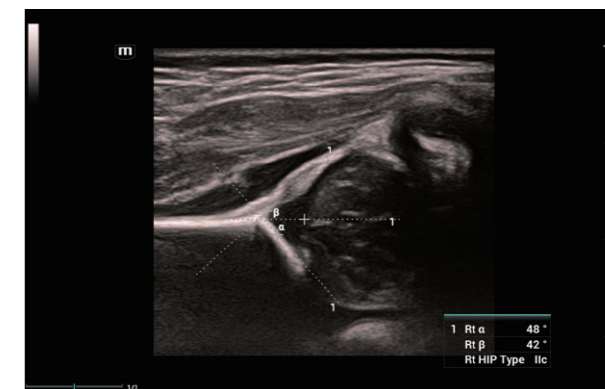

Smart Hip

## Post-partum solution

### Extremely easy diagnosis of pelvic floor disorders-- Smart Pelvic

It greatly simplifies the operation procedures, and minimizes the exam time for a standardized evaluation of pelvic floor, whether for the anterior pelvic compartment or anal levator hiatus. With extremely simple user-interaction, it generates a standard coordinate system and fully automatically provides all related measurements within a few seconds. It additionally offers auto acquisition of multiple parallel planes while symphysis pubis is "open, closing and closed".

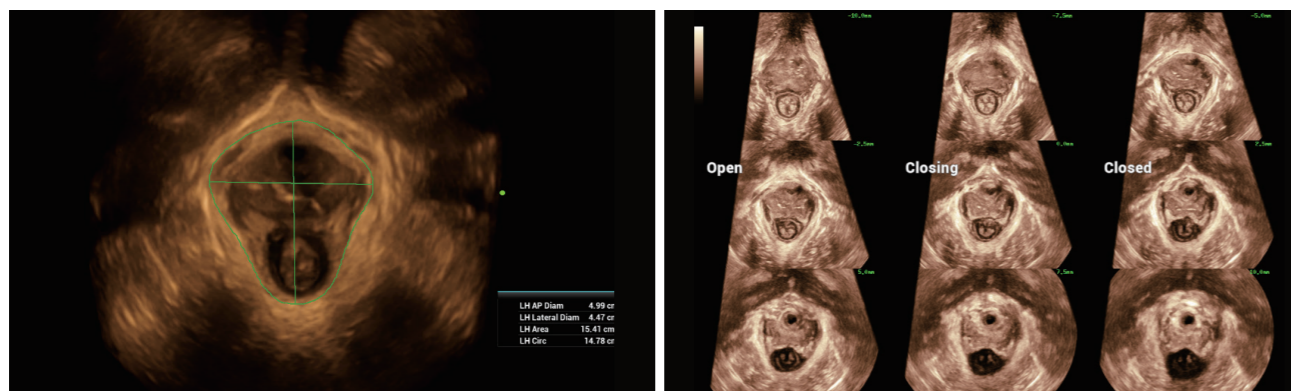

Smart Pelvic

Auto planes acquisition



# Superb confidence with extreme clarity



Fetal face 3D

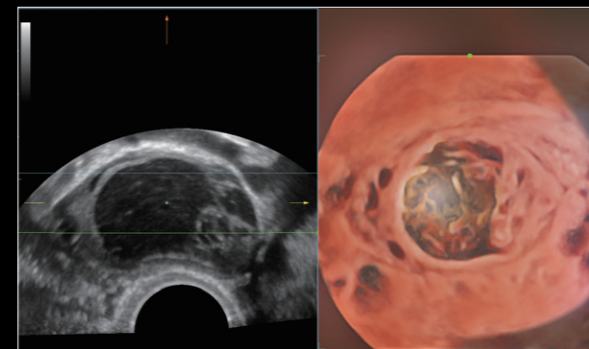

Ovarian tumor

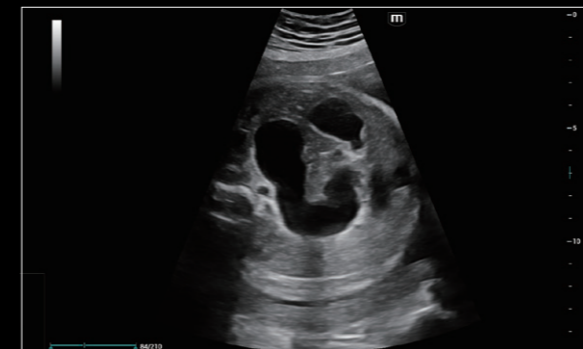

Fetal gastrointestinal dilatation



Fetal spine 3D

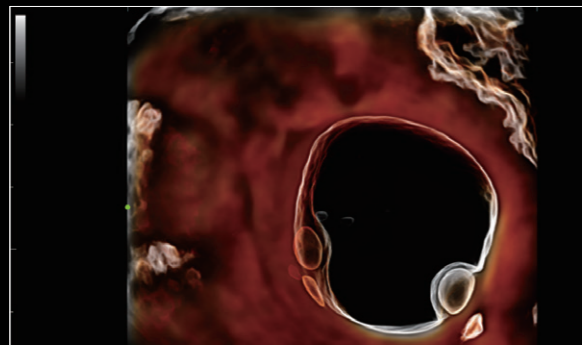

Follicle 3D

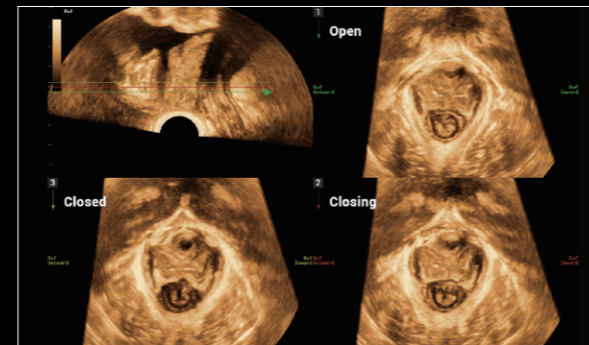

Smart Pelvic



Early OB fetus

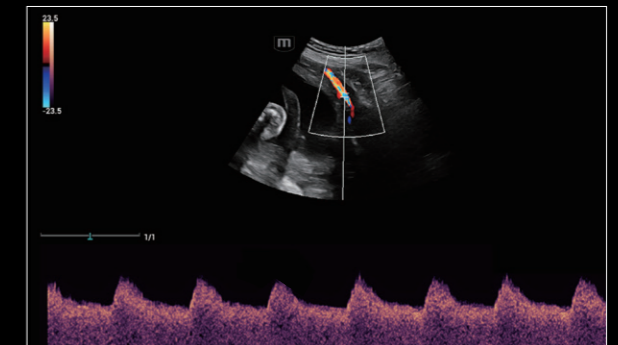

Uterine artery PW



Corpus callosum and cerebellar vermis

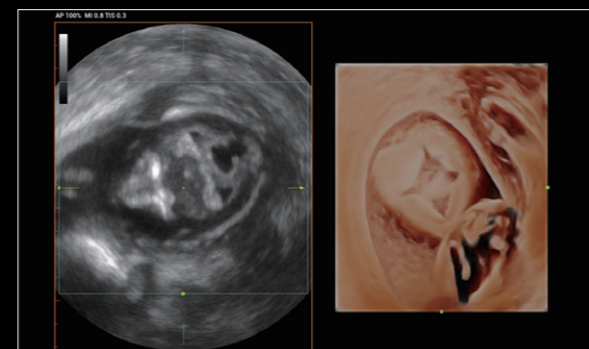

Fetal brain malformation

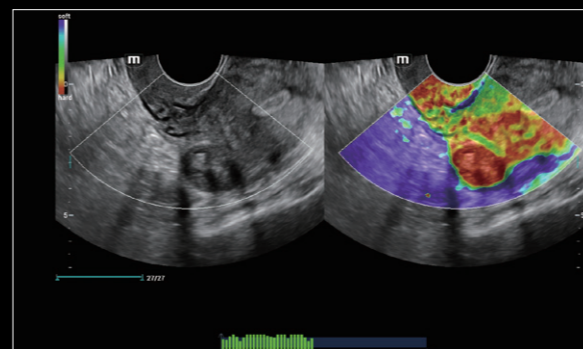

Uterine myoma elastography



Early OB fetus with iLive



Fetal heart



Fetal face

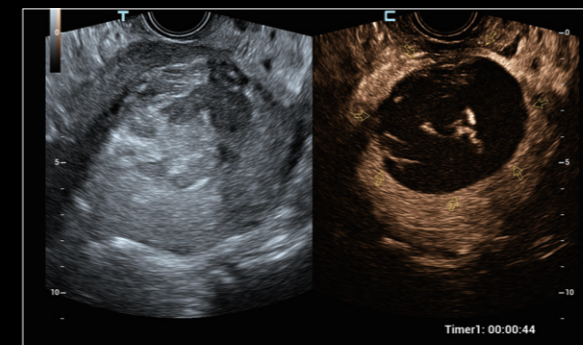

CEUS of uterine mass



Fetal varus foot